

## 20CJQ045 SCHOTTKY RECTIFIER

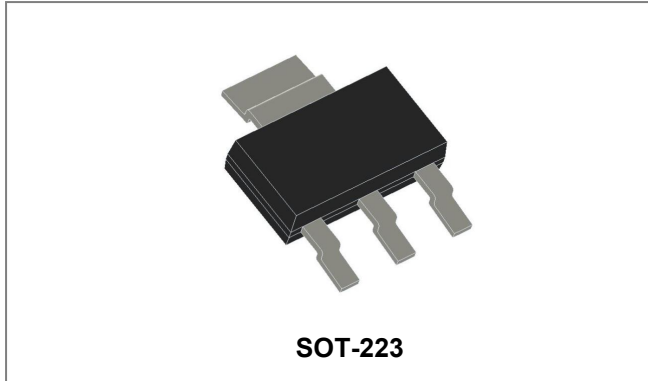

### Features

- 150 °C T<sub>J</sub> operation
- Low forward voltage drop
- High purity, high temperature epoxy encapsulation for enhanced mechanical strength and moisture resistance
- High frequency operation
- Guard ring for enhanced ruggedness and long term reliability
- Terminals finish: 100% Pure Tin
- This is a Pb – Free Device
- All SMC parts are traceable to the wafer lot
- Additional testing can be offered upon request

### Circuit Diagram

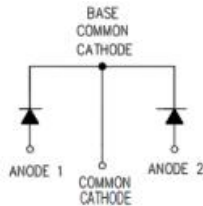

### Applications

- Switching power supply
- Redundant power subsystems
- Converters
- Free-Wheeling diodes
- Reverse battery protection

### Maximum Ratings:

Characteristics	Symbol	Condition	Max.	Units
Peak Repetitive Reverse Voltage Working Peak Reverse Voltage DC Blocking Voltage	V <sub>RRM</sub> V <sub>RWM</sub> V <sub>R</sub>	-	45	V
Average Rectified Forward Current	I <sub>F(AV)</sub>	50% duty cycle @T <sub>c</sub> =127°C, rectangular wave form	1(Per Leg) 2(Per Device)	A
Peak One Cycle Non-Repetitive Surge Current(Per Leg)	I <sub>FSM</sub>	8.3ms, Half Sine pulse, T <sub>C</sub> = 25 °C	26	A

### Electrical Characteristics:

Characteristics	Symbol	Condition	Typ.	Max.	Units
Forward Voltage Drop (Per Leg)*	V <sub>F1</sub>	@ 1A, Pulse, T <sub>J</sub> = 25 °C	0.52	0.54	V
		@ 2A, Pulse, T <sub>J</sub> = 25 °C	0.63	0.67	
Reverse Current (Per Leg)*	I <sub>R1</sub>	@V <sub>R</sub> = rated V <sub>R</sub> , T <sub>J</sub> = 25 °C	0.004	0.1	mA
		@V <sub>R</sub> = rated V <sub>R</sub> , T <sub>J</sub> = 125 °C	0.4	10	
Junction Capacitance(Per Leg)	C <sub>T</sub>	@V <sub>R</sub> = 5V, T <sub>C</sub> = 25 °C f <sub>sig</sub> = 1MHz	49	60	pF

\* Pulse width < 300 μs, duty cycle < 2%

**Thermal-Mechanical Specifications:**

Characteristics	Symbol	Condition	Specification	Units
Junction Temperature	$T_J$	-	-55 to +150	°C
Storage Temperature	$T_{stg}$	-	-55 to +150	°C
Typical Thermal Resistance Junction to Lead	$R_{\theta JL}$	DC operation	25	°C/W
Typical Thermal Resistance Junction to Ambient	$R_{\theta JA}$	DC operation	65	°C/W
Approximate Weight	wt	-	0.13	g
Case Style	SOT-223			

**Ratings and Characteristics Curves**

Figure 1 Typical Forward Characteristics

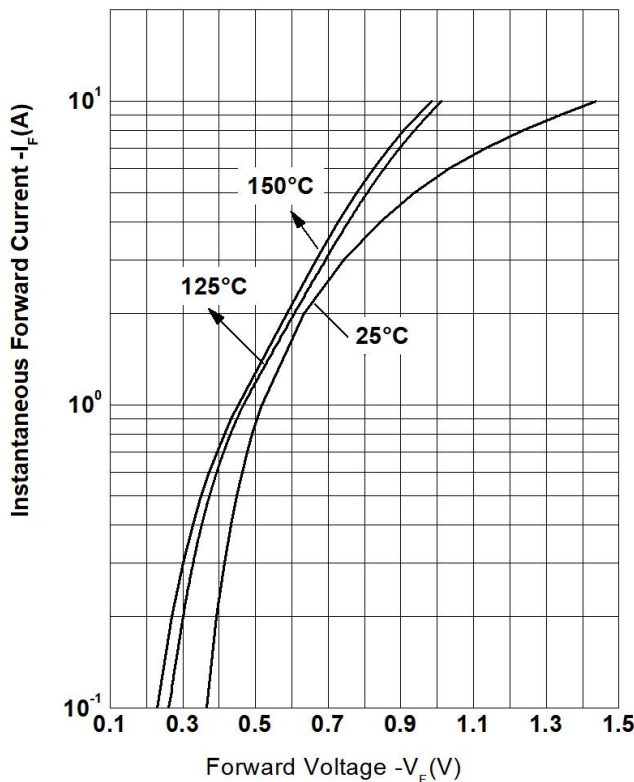

Figure 2 Typical Reverse Characteristics

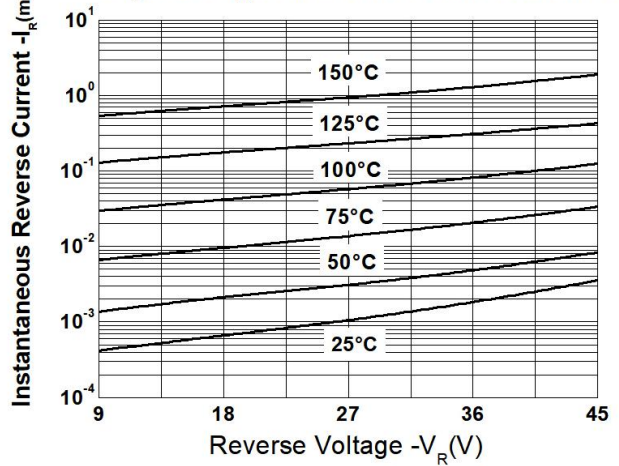
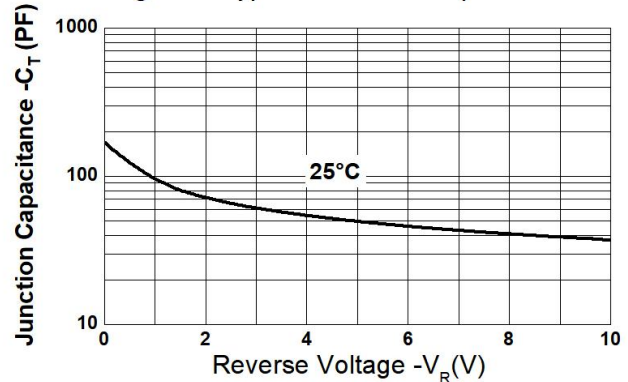

Figure 3 Typical Junction Capacitance



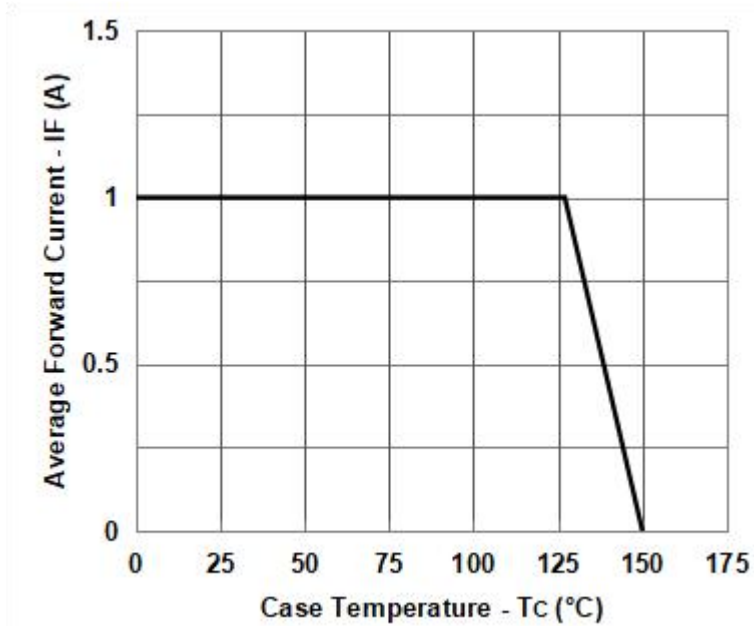
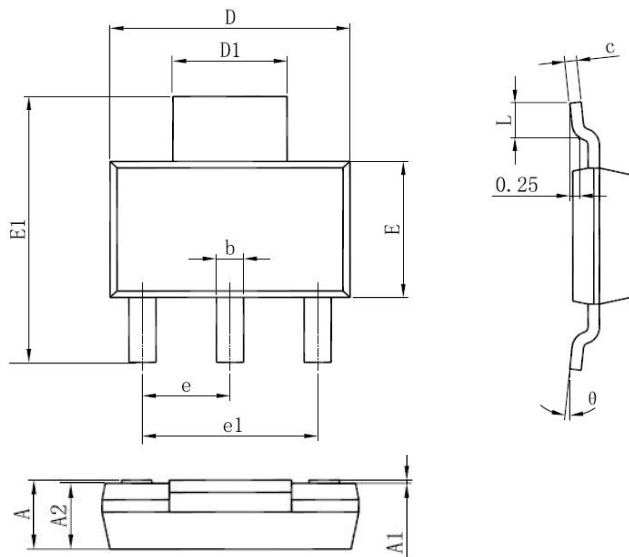

Fig.4 Max. Allowable Case Temperature Vs. Average Forward Current (Per Leg)

**Mechanical Dimensions SOT-223**



SYMBOL	Millimeters		Inches	
	MIN.	MAX.	MIN.	MAX.
A	1.520	1.800	0.060	0.071
A1	0.000	0.100	0.000	0.004
A2	1.500	1.700	0.059	0.067
b	0.660	0.820	0.026	0.032
c	0.250	0.350	0.010	0.014
D	6.200	6.400	0.244	0.252
D1	2.900	3.100	0.114	0.122
E	3.300	3.700	0.130	0.146
E1	6.830	7.070	0.269	0.278
e	2.300(BSC)		0.091(BSC)	
e1	4.500	4.700	0.177	0.185
L	0.900	1.150	0.035	0.045
θ	0°	10°	0°	10°

**Ordering Information**

Device	Package	Shipping
20CJQ045	SOT-223 (Pb-Free)	3000pcs / reel
20CJQ045TR	SOT-223 (Pb-Free)	3000pcs / reel

For information on tape and reel specifications, including part orientation and tape sizes, please refer to our tape and reel packaging specification.

**Marking Diagram**

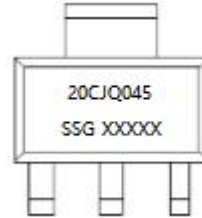

Where XXXXX is YYWWL

20CJQ045 = Part Name  
SSG = SSG  
YY = Year  
WW = Week  
L = Lot Number

**Carrier Tape Specification SOT-223**

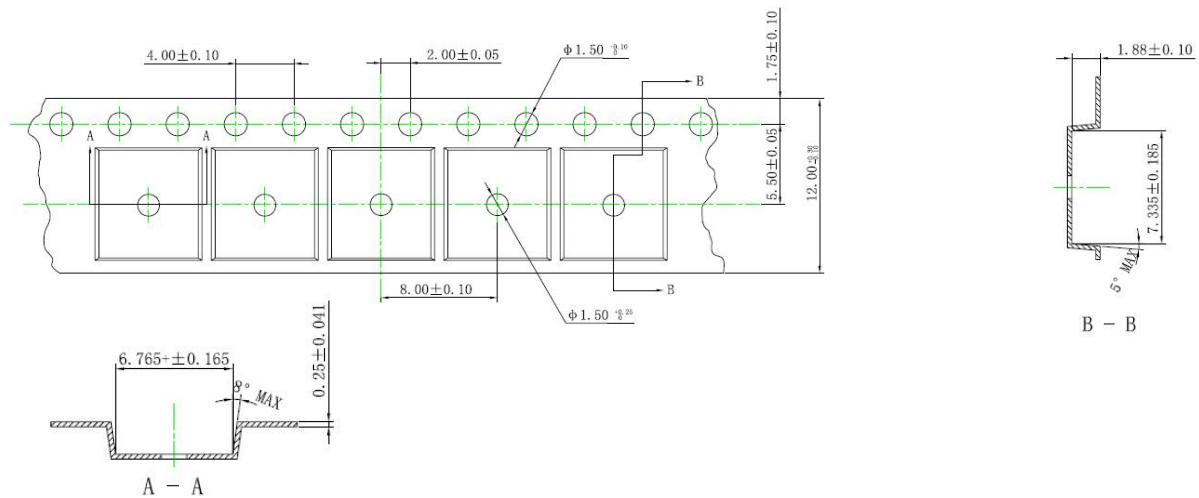

**Technical Data**  
**Data Sheet N2262, Rev. A**



**DISCLAIMER:**

- 1- The information given herein, including the specifications and dimensions, is subject to change without prior notice to improve product characteristics. Before ordering, purchasers are advised to contact the SMC Diode Solutions sales department for the latest version of the datasheet(s).
- 2- In cases where extremely high reliability is required (such as use in nuclear power control, aerospace and aviation, traffic equipment, medical equipment, and safety equipment), safety should be ensured by using semiconductor devices that feature assured safety or by means of users' fail-safe precautions or other arrangement.
- 3- In no event shall SMC Diode Solutions be liable for any damages that may result from an accident or any other cause during operation of the user's units according to the datasheet(s). SMC Diode Solution assumes no responsibility for any intellectual property claims or any other problems that may result from applications of information, products or circuits described in the datasheets.
- 4- In no event shall SMC Diode Solutions be liable for any failure in a semiconductor device or any secondary damage resulting from use at a value exceeding the absolute maximum rating.
- 5- No license is granted by the datasheet(s) under any patents or other rights of any third party or SMC Diode Solutions.
- 6- The datasheet(s) may not be reproduced or duplicated, in any form, in whole or part, without the expressed written permission of SMC Diode Solutions.
- 7- The products (technologies) described in the datasheet(s) are not to be provided to any party whose purpose in their application will hinder maintenance of international peace and safety nor are they to be applied to that purpose by their direct purchasers or any third party. When exporting these products (technologies), the necessary procedures are to be taken in accordance with related laws and regulations..